

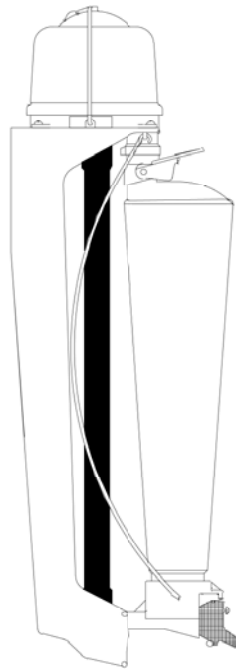

WAIKATO

Mk V Milk Meter



TECHNICAL MANUAL

Part Number: 39860132

© Waikato Milking Systems NZ Ltd, 2002

WAIKATO MILKING SYSTEMS NZ LIMITED
558 Te Rapa Rd, P O Box 20055 Hamilton, New Zealand
Telephone: 07-849 8755, International +64-7-849 8755. Facsimile: 07-849 0164, International +64-7-849 0164
www.waikatomilking.co.nz

i	Contents
ii	Document Control
1	Introduction
2	Features
3	Description
	3.1. The Milk Meter
	3.2. Measuring Flask Options
	3.3. Sampling
	3.4. Mounting Options
	3.4.1 Permanent Mounting
	3.4.2 Detachable Mounting
	3.5. Labelling Variations
	3.6. Quality Assurance
	3.7. Waikato Mk V Milk Meter Approval
	3.8. Major Parts Of The Milk Meter
4	Installation
	4.1 Location
	4.2 Milk Tube Size
	4.3. Installation With Automatic Cluster Removers
	4.4. Use With Alfa-Laval Duovac (Or DV300)
	4.5. Waikato Milk Meter Conversion From 30kg (65lb) To 42kg (92lb) Capacity
5	Operation
	5.1 To Operate The Meter With Open Bottom Flask
	5.2 To Operate The Meter With Closed Bottom Flask
6	Cleaning Procedures
	6.1. Clean In Place Procedure
	6.1.1. Before Milking
	6.1.2. Immediately After Use
	6.1.3. Reverse Flow Cleaning Systems
	6.1.4. Alkaline Detergents
	6.2. Manual Cleaning Procedure
7	Routine Maintenance

8	Milking Machine Requirements <ul style="list-style-type: none">8.1. Effective Vacuum Reserve8.2. Vacuum Level8.3. Air Admission At The Claw8.4. Long Milk Tube8.5. Milk Pipe Slope And Size8.6. Restricting Tubes And Fittings
9	Trouble Shooting <ul style="list-style-type: none">9.1. Operational Problems<ul style="list-style-type: none">9.1.1. Air Bubbling Up Through Milk In Flask9.1.2. Milk Does Not Enter Flask When Cow Is Milking9.1.3. Milk Sample Not Released When Flask Depressor Operated9.2. Accuracy Problems9.3. Cleaning Problems
10	Periodic Inspection <ul style="list-style-type: none">10.1. Dismantling10.2. Inspection
11	Periodic Test Procedure <ul style="list-style-type: none">11.1. Basic Test Rig Set Up11.2. Basic Test Procedure11.3. Results Analysis
12	Repair And Recalibration Procedure <ul style="list-style-type: none">12.1. Damaged Milk Meters12.2. Milk Meters That Fail 'Periodic Test Procedure'
13	Warranty

Section	Contents	Page	Current Issue
i	Contents	1	B 19-Feb-03
ii	Document Control	3	B 19-Feb-03
1	Introduction	4	B 19-Feb-03
2	Features	5	B 19-Feb-03
3	Description	6	B 19-Feb-03
4	Installation	12	B 19-Feb-03
5	Operation	14	B 19-Feb-03
6	Cleaning	17	B 19-Feb-03
7	Routine Maintenance	19	B 19-Feb-03
8	Milking Machine Requirements	20	B 19-Feb-03
9	Trouble Shooting	22	B 19-Feb-03
10	Periodic Inspection	24	B 19-Feb-03
11	Periodic Test Procedure	26	B 19-Feb-03
12	Repair and Recalibration Procedure	29	B 19-Feb-03
13	Warranty	30	B 19-Feb-03

Authorised: I H Gunn Project Manager

1. INTRODUCTION

The Waikato Milk Meter is a milk yield proportioning device that fits into the long milk tube between each milking unit and the milk pipeline.

The Milk Meter retains a known small proportion of the yield in a calibrated flask, from which the cows' total yield may be read, or the flask may be removed for weighing and the sampling ratio applied to obtain the milk yield.

The flask contents may then be gently agitated and a smaller representative sub-sample drawn off for milk component analysis.

Milk Meters are an important management aid on any dairy farm. With the regular use of Milk Meters, the farmer can select high producing cows for future breeding purposes or low producing cows for culling or that require attention. Also, by knowing a cow's milk production, the farmer is better equipped to judge supplementary feed requirements.

2. FEATURES

- Accurate - meets ICAR (International Committee for Animal Recording) and DHIA criteria.
- Independently approved for use in fifteen of the major dairying countries of the world.
- Measuring capacity options - 42kg (92lb) or 30kg (65lb) or 4.5L goat flasks.
- Tapered flask improves reading accuracy at low yields.
- Yield read off calibrated flask in place or flask removable for reading or sampling.
- Representative sub-sample can be taken for analysis.
- Low resistance to milk flow.
- No small ports to block.
- Mounting options for any dairy.
- Portable or permanent mounting.
- Sampling ratio of 25gram/kilogram (Nominal).
- Constructed of durable, hygienic, dairy grade materials.

3. DESCRIPTION

3.1. THE MILK METER (refer to Fig 3.1)

The Milk Meter has a central milk inlet tube (D) in which the milk moves up from the claw with each pulsation of the milking machine.

Spiral vanes (C) near the top of the inlet tube rotate the milk which leaves the inlet tube to be spread out umbrella fashion by the top of the cover (B).

The resultant film of milk spread over the inside of the meter cover is then sampled by a divider orifice (A).

The resultant milk sample passes into the measuring flask (E) while the bulk of the milk continues through the outlet tube (F) into the milking system.

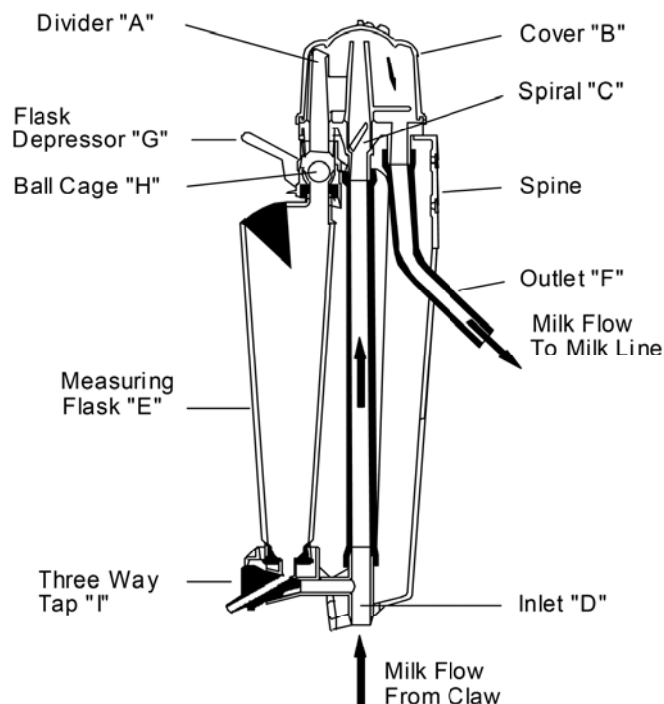

Fig 3.1 Cutaway view of the Waikato MkV Milk Meter

3.2. MEASURING FLASK OPTIONS

- a. 30kg flask - ICAR approved one piece moulding.
- b. 42kg flask - flask cap and seal are removable for cleaning if desired.

Flask bungs are not interchangeable between 42kg and 30kg flasks.

The Milk Meter is normally fitted with an open bung in the flask base. However, if it is desired to remove the flask after each cow for further analysis, or weighing, then a closed bung can be fitted.

With the flask removed from the meter or when the flask depressor (G Fig 3.1) is operated the stainless steel ball in the ball cage assembly (H Fig 3.1) prevents excessive air admission to the milking system.

The open bottom flask should be reinserted for washing.

3.3. SAMPLING

A milk sample for fat analysis can be collected direct from the Milk Meter when an open bottom flask is fitted, by operating the 3 way tap (I Fig 3.1) (See Section 5 for procedure).

The various positions of the 3 way tap, combined with operation of the flask depressor, enable milking, sample agitation and collection, washing and draining, to take place.

3.4. MOUNTING OPTIONS (ref to Fig 3.2)

The Milk Meter may be installed permanently or readily detachable.

It may be fitted to flat surfaces or vertical or horizontal piping so long as the Milk Meter Base remains in a horizontal ($\pm 5^\circ$) orientation.

3.4.1. PERMANENT MOUNTING

- To flat surface (Fig 3.2a)
- To vertical or horizontal piping (Fig 3.2b)

3.4.2. DETACHABLE MOUNTING

- Stem and Wedge Mounting Set (Fig 3.2c) for flat surfaces or piping.

- Wedge Mounting Set (Fig 3.2 d and e) for flat surfaces or piping.
- Hanger bracket (Fig 3.2 f) off piping.

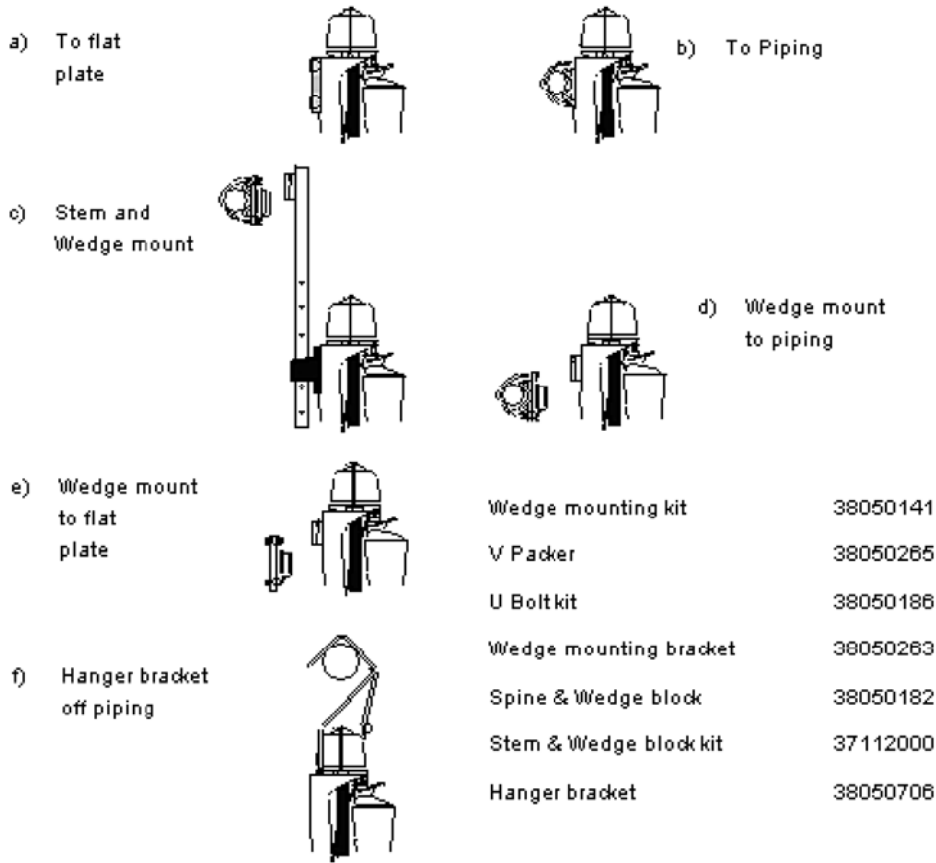

Fig 3.2 Milk Meter Mounting Options



Fig 3.2i Wedge Mounting Kitset

3.5. LABELLING VARIATIONS

The Waikato Mk V Milk Meter is marketed in most of the dairying countries of the world and may be labelled differently depending on the distributor in each country.

In each case the basic Milk Meter is the same. The only structural differences between labels are the presence or absence of fittings such as spine assembly, mounting set, or packaging.

3.6. QUALITY ASSURANCE

Each Milk Meter is manufactured and assembled to strict quality control criteria and each Milk Meter is tested under simulated milking conditions.

This ensures that Milk Meters on leaving the factory are accurate to within plus or minus 1.3% at a yield of 15kg.

It is recommended that each Milk Meter be subjected to at least an annual inspection and test procedure as detailed in the Periodic Inspection section of this manual.

If repair or recalibration is required this should be carried out only by suitably trained personnel. For example, in the United States of America, only at DHIA Certified Repair and Recalibration Centres.

3.7. WAIKATO Mk V MILK METER APPROVAL

The Waikato Mk V Milk Meter has been approved by ICAR (International Committee for Animal Recording). Also the Milk Meter has the approval of individual testing authorities in the following countries:

Australia	Canada	Japan
England	France	Italy
Germany	Holland	Sweden
Ireland	New Zealand	Korea
Scotland	Wales	South Africa
USA	Denmark	

3.8. MAJOR PARTS OF THE MILK METER

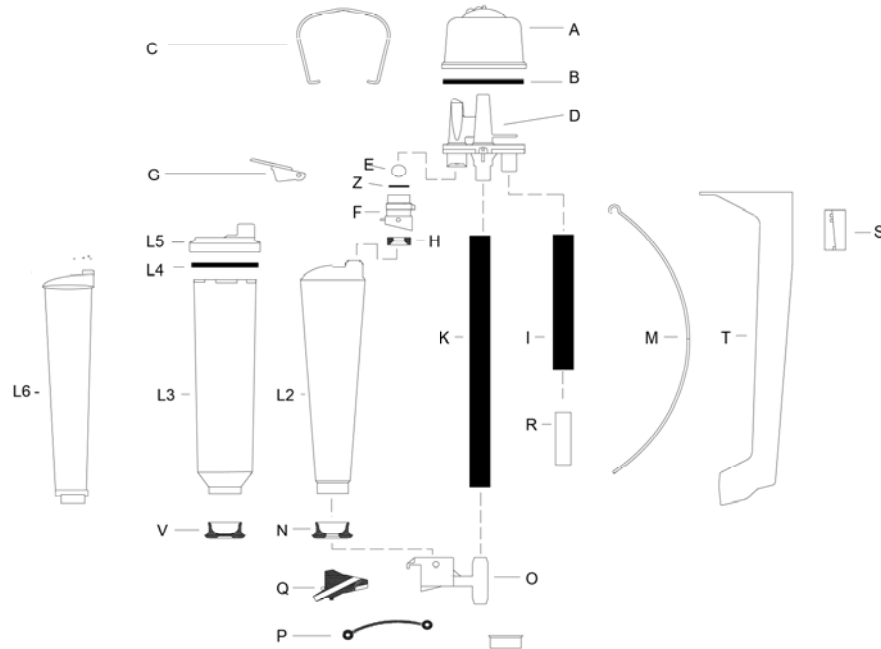

Fig. 3.3 Major Parts Of Milk Meter

PART		30 kg #	42 kg #	Goat #
A	Cover	38050251	38050251	38050251
B	Cover Seal	38050301	38050301	38050301
AB	Cover Assembly	38050122	38050122	38050122
C	Cover Clip	38050703	38050703	38050703
ABD	Assembly Base & Cover	38050160	38050160	
D	Base			3711916
E	Stainless Steel Ball	38050801	38050801	38050801
F	Ball Cage	38050163	38050163	38050163
G	Flask Depressor	38050260	38050260	38050260
H	Valve Housing Gasket	38050503	38050503	38050503
Z	'O' Ring	38050504	38050504	38050504
FGHZ	Ball Cage Assembly	38050165	38050165	38050165
I	Short Tube	38050505	38050505	38050505
R	Stainless Steel Connector	38050704	38050704	38050704
IR	S/S Connector Assembly	38050166	38050166	38050166
K	Hose	38050506	38050506	38050506
L-2	Flask (30kg)	38050164		
L-3	Flask (42kg)		38050146	
L-4	42kg Flask Seal		38050219	
L-5	42kg Flask Top		38050268	
L-3,4,5 N	42kg Flask Assembly - Open Bung		38050194	
L-3,4,5 V	42kg Flask Assembly - Closed Bung		38050195	
L-6	Flask (Goat)			38067164
M	Flask Wires (pair)	38050702	38050702	38050702
N	Bung - Open Flask	38050502	38050508	38050502
V	Bung - Closed Flask	38050507	38050509	
O	Tap Housing	38050262	38050262	38050262
P	Tap Strap	38050217	38050217	38050217
Q	3 Way Tap	38050207	38050207	38050207
PQ	Tap with Strap	38050185	38050185	38050185
T	Spine Bracket	38050216	38050216	38050216
ST	Spine with Wedge Block	38050182	38050182	38050182

4. INSTALLATION

4.1. LOCATION (refer to Fig 4.1)

The Milk Meter is installed in the long milk tube between the milking unit and the milk pipeline.

It should be mounted in such a position that it is not vulnerable to cow damage and likewise does not cause injury or interference to cows. Consideration should also be given to operator convenience in reading the measuring flask.

The Milk Meter should be mounted rigidly enough (refer Fig 3.2) so that cow or other movement does not pull the meter base away from horizontal. A tolerance of $\pm 5^\circ$ is acceptable.

4.2. MILK TUBE SIZE

The minimum recommended milk tube size is nominally 13mm (1/2") internal diameter.

The Milk Meter inlet and outlet nipples will accommodate up to 16mm (5/8") internal diameter tubing.

4.3. INSTALLATION WITH AUTOMATIC CLUSTER REMOVERS

In dairies with Automatic Cluster Removers (ACR's) the Milk Meter should be installed between the vacuum shut-off and milk pipeline.

This ensures the Milk Meter remains under vacuum so that sample draining and resetting can be carried out.

If slow milking and cup falls are a problem when Milk Meters are installed with ACR's, consider increasing the vacuum level by up to 3 kPa (1" Hg) and ensure the vacuum level is restored to its original setting when Milk Meters are removed. On no account should the vacuum level be set above 50kPa (15" Hg).

4.4. USE WITH ALFA-LAVAL DUOVAC (or DV300)

Where the Duovac (DV 300) is installed the Milk Meter may be fitted either side of the Duovac and the Duovac switched to manual.

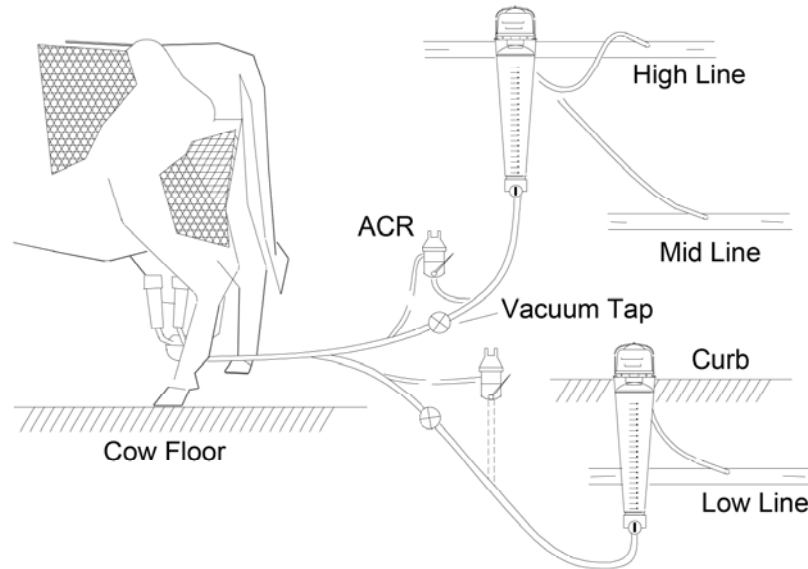

Fig 4.1 Installation of Milk Meters

4.5. WAIKATO MILK METER CONVERSION FROM 30kg (65lb) TO 42kg (92lb) CAPACITY

With the exception of the flask, bungs (open and closed) and ball cage housing, parts are interchangeable between the two capacities of Milk Meter. 30kg meters may therefore be readily converted to 42kg.

The 42kg flask with cap, seal and bung fits in place of the 30kg flask.

NB. Ensure hose K (Fig 3.3) does not exceed 27mm outside diameter or it may restrict flask movement.

The lug on the ball cage housing (30kg meter, part F, Fig 3.3) restricts the flask depressor travel on the 42kg flask, so it should be snipped off, or a modified ball cage assembly fitted.

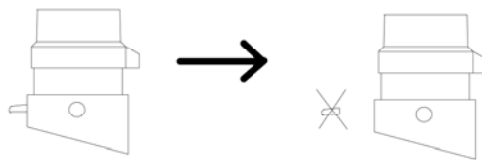
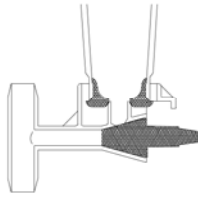

Fig 4.2 42kg Ball Cage Housing

5. OPERATION

5.1. TO OPERATE THE METER WITH OPEN BOTTOM FLASK

1. Wet flask tap centre before use.
2. Close flask tap by turning to horizontal position. Rock tap in its seat to ensure the tap is firmly seated.
3. Place cups on cow. Milk in usual manner.
4. Remove cups from cow. Milk Meter should still be under vacuum.
5. Read Milk Level (ignoring froth) in the measuring flask to give milk yield in kg or lb. (allow time for excessive froth to settle before reading).
6. If a milk sample is required for testing,
 - a. Turn flask tap down to the sampling position.
 - b. Allow air to be admitted into the measuring flask for one second per kg of milk, a minimum of ten seconds. e.g. for 25 kg's of milk allow air to be admitted for a minimum of 25 seconds.
 - c. Operate the flask depressor to draw off a sub sample of milk as required.
7. To empty flask turn tap up and operate flask depressor. Wait a few seconds after flask drains and operate flask depressor again if necessary.
8. Turn flask tap to horizontal for next cow or leave pointing up for washing.



- a) Milking (or closed) position.
Tap outlet pointing left or right (ie. horizontal).

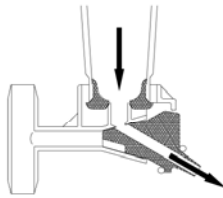

- b) Sampling position. Tap outlet pointing down admits air to the flask for milk agitation.
Operating flask depressor releases sample via tap outlet.

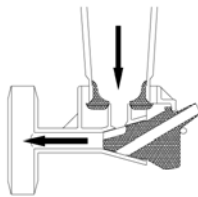

- c) Washing and Emptying position.
Tap outlet points up for in-place washing.
Operating flask depressor empties flask contents back into milking system.

Fig 5.1 Three-Way Tap Positions

5.2. TO OPERATE THE METER WITH CLOSED BOTTOM FLASK

For reading flask, and sampling, away from cow side, Dairy Research, or further analysis.

1. Close flask tap firmly (refer Fig 5.1a), insert closed bottom flask and proceed as above.
2. At the end of each cow's milking, remove the flask with sample by operating flask depressor, pulling flask down out of the seal under the meter head and lifting away.
3. The stainless steel ball valve will prevent excessive air admission when flask is removed.
4. To mix the flask contents for sub-sampling, plug the flask entry hole with a rubber bung and gently invert the flask three times. A sub-sample may then be poured out.
5. When milking is finished, place open bottom flask in the meter, turn the flask tap to wash (Fig 5.1c) and clean the milking machine as per the cleaning procedure section of this manual.

6. CLEANING PROCEDURES

Under normal circumstances the Waikato Mk V Milk Meter may be satisfactorily washed with a 'Clean in Place' system, although some herd testing authorities require that the flask be removed and washed manually.

A 'manual cleaning' procedure is included as it may be required as part of the Periodic Inspection Section of this manual, if the Milk Meters have been used with substandard cleaning systems.

CAUTION:

Do not use abrasive pads or powders on the Milk Meters as these may scratch the surface.

Do not use organic solvents or hydrocarbons to clean the plastic parts of the Milk Meters.

Do not use brushes, abrasive pads or any implement on the Milk Meter base (including divider orifice and inlet) or cover.

6.1. CLEAN IN PLACE PROCEDURE

Milking machine cleaning routines depend on the detergent manufacturer's recommendations on volume, temperature, and concentration. The following suggested routine should therefore be used in conjunction with the detergent manufacturer's recommendations.

Turn the flask tap upwards for all cleaning routines (refer Fig.5.1c)

6.1.1. BEFORE MILKING

Flush the milking machine (with Milk Meters) in the normal manner using an acid sanitiser solution at recommended concentration, temperature and volume.

This step must be carried out prior to milking if the Milk Meter has not been used for several days.

6.1.2. IMMEDIATELY AFTER USE

1. Flush the complete milking machine (with Milk Meters), using cold or tepid water until the discharged water is clear.

2. Wash the complete milking machine and Milk Meters with dairy detergent solution at recommended temperature, concentration and volume.
3. Flush the milking machine and Milk Meters with hot water (above 65°C, 150°F).
4. Operate the flask depressor on each Milk Meter to drain each flask, or keep vacuum pump running until each flask is empty.
5. Wash off any dirt or dust from exterior of Milk Meters using a sponge or soft cloth with warm detergent solution, followed by a water rinse.
6. Some Testing Authorities require that the flask be removed and washed manually. (refer to Section 6.2 'Manual Cleaning Procedure').

6.1.3. REVERSE FLOW CLEANING SYSTEMS

The Milk Meters can be cleaned in place as above but the flasks may need to be removed and cleaned manually on some milking systems.

6.1.4. ALKALINE DETERGENTS

It is important that any milking machine is washed regularly with an alkaline detergent. All rubber components have a tendency to absorb milk fat, resulting in swelling and distortion of the component. A regular alkaline wash will minimise the effect of this.

6.2. MANUAL CLEANING PROCEDURE

(For use as part of the "Periodic Inspection Procedure" if required).

1. Immerse the Milk Meter(s) or parts thereof in a wash tank with water and detergent at 50° C (120° F) or hotter.
2. "Soak and shake" to clean. A sponge may be used to remove stubborn deposits.
3. Rinse with ample fresh warm water.

7. ROUTINE MAINTENANCE

The Milk Meter has been designed to require minimum maintenance. However, as part of 'operator technique' the user should become conditioned to noticing any abnormality such as:

- Foreign matter in the meter head
- Worn, damaged, or missing meter components (air leaks are possible indications of this).

All Milk Meters should be inspected for the above faults at regular intervals.

Milk Meters moved from farm to farm should be inspected before installation at each farm.

Permanently mounted meters should be inspected for foreign matter in the meter head at least weekly, and for wear or damage every three months.

If repairs to a Milk Meter appear necessary it should be put through the "Periodic Inspection" (section 10), and if necessary the "Periodic Test" (section 11) and "Repair and Recalibration" (section 12). In any case it is recommended that all Milk Meters be subject to the "Periodic Inspection" and "Periodic Test" at least once annually.

8. MILKING MACHINE REQUIREMENTS

For the sake of cow health, all milking machines should at all times perform to standard requirements. Variations in standards occur from country to country but in general the intention to preserve cow health is the same.

For accurate efficient Milk Meter performance the milking machine must comply with the generally accepted standard performance requirements (for example ISO 5707).

Performance parameters that should be given specific attention when Milk Meters are used are as follows:

8.1. EFFECTIVE VACUUM RESERVE

A low effective reserve could lead to an unstable and fluctuating vacuum level due to the resultant extended vacuum level recovery time.

Fluctuations would increase at times of intermittent excessive air admission such as at cup fall, or poor cups handling technique.

Unstable vacuum levels could cause milk plugging in the long milk tube and hence flooding of the Milk Meter.

8.2. VACUUM LEVEL

Milk Meters are designed to work at a stable vacuum level in the range 40kPa to 50kPa (12 " Hg to 15 " Hg).

The minimal vacuum drop across the Milk Meter may reduce the milking vacuum level at the cow. This would slow down milking rate but not affect accuracy. To compensate for this, milking vacuum may be increased by up to 3kPa (1" Hg) when Milk Meters are fitted.

Note: On no account should the vacuum level ever be set greater than 50kPa (15" Hg).

8.3. AIR ADMISSION AT THE CLAW

Air admission is essential for transporting the milk through the milk tube.

No, or low air admission would cause flooding of the milk tube, Milk Meter, and Claw. Excessive air admission would increase the amount of froth in the milk, physically damaging the fat globule membrane.

The recommended minimum air admission to the claw is 4 litres/min.

8.4. LONG MILK TUBE

The minimum recommended internal diameter is 13mm (0.5").

Small diameters could cause excessive milk flow restriction, "plugging" in the long milk tube, and hence an unstable milking vacuum.

8.5. MILK PIPE SLOPE AND SIZE

All milk pipelines should have a minimum slope of 1 in 200 and be sized such that a flooded pipe situation does not occur at peak milk flow.

8.6. RESTRICTING TUBES AND FITTINGS

All tubes, nipples and fittings should be inspected to ensure they are free of damage, and not creating a restriction to flow.

Claw nipples with a narrow spread sometimes restrict flow when on cows with widely spread teats.

Non-compatibility of liner and cup can cause a restriction at the exit hole in the cup.

Any abnormal restrictions such as these can affect Milk Meter accuracy.

9. TROUBLE SHOOTING

9.1. OPERATIONAL PROBLEMS

9.1.1. AIR BUBBLING UP THROUGH MILK IN FLASK

- Cause: 3 way tap worn, dry or not properly seated.
Remedy: Replace, wet, or push home while rocking tap centre.

9.1.2. MILK DOES NOT ENTER FLASK WHEN COW IS MILKING

- Cause 1: Tap in wrong position.
Remedy 1: Turn tap to milking (horizontal) position.
Cause 2: Air leaks at ball cage or tap housing.
Remedy 2: Locate and fix air leaks.

9.1.3. MILK SAMPLE NOT RELEASED WHEN FLASK DEPRESSOR OPERATED

- Cause 1: Tap in wrong position.
Remedy 1: Turn tap to sampling (down) position.
Cause 2: Ball cage not seated properly so stainless steel ball will not lift.
Remedy 2: Push ball cage firmly onto spigot on meter base. A light coating of water, detergent or glycerine on the mating surfaces would help here.

9.2. ACCURACY PROBLEMS

9.2.1. MILK METER ACCURACY CAN BE CHECKED BY TWO METHODS:

- a. Compare individual cow yields (from weighing and sampling total yield in a test bucket) with the reading and sample from the Milk Meter.
- b. Test the Milk Meter on a test rig using water as the test liquid (refer "Periodic Test Procedure" section 11).

The following causes of inaccuracy are applicable to one or both methods.

- a. Milking machine performance below standard (refer to section 8 Milking Machine Requirements).
- b. Milk Meter not correctly installed.

- c. Milk Meter base pulled off horizontal by cow movement or incorrect bracket mounting.
- d. Milk flow back to the Milk Meter or test bucket from the milk pipe line.
- e. Milk in flask from the previous cow.
- f. Milk Meter tap in wrong position.
- g. Foreign matter in meter head.
- h. Damaged parts of Milk Meter, especially divider orifice lips.
- i. Operator error in reading milk yield.
- j. Scales used to weigh test bucket contents out of calibration.
- k. Incorrect mixing or sampling technique.
- l. Butterfat samples not taken in duplicate.

9.3. CLEANING PROBLEMS

If a milking machine cleaning system is only just adequate without Milk Meters, then the installation of Milk Meters could give rise to cleaning problems, due to the extra cleaning load.

The following parameters could be changed to improve an inadequate cleaning system.

- Increase cleaning solution volume
- Flow rate
- Concentration
- Temperature

A cleaning system that is clearly inadequate would require redesigning for efficient cleaning.

10. PERIODIC INSPECTION

Each Waikato Milk Meter should be submitted to the following inspection procedure at least once annually.

(Refer to Fig 3.3 for parts identification).

10.1. DISMANTLING

Remove:

- Three way tap from tap housing.
- Flask from Milk Meter (pull flask down and away from ball cage housing).
- Bung from flask.
- Ball cage assembly from meter base (twist to the left and pull down).
- Ball, 'O' ring and gasket from ball cage assembly (a small blunt implement like a screwdriver may be useful for removing the 'O' ring).
- Cover from meter base.

Further dismantling is unnecessary as all parts may be inspected at this stage.

10.2. INSPECTION

Inspect all parts for any build up of milkstone, milk fat, or other deposits due to inadequate cleaning systems. If these are present use the 'manual cleaning procedure'.

DO NOT use brushes inside the cover or near base assembly.

DO NOT use abrasives or organic solvents to clean Milk Meter parts.

Closely inspect all the following parts for perishing, surface hardness, cuts, splits or excessive scratching.

- Three Way Tap
- Inlet and Outlet Hoses
- Flask Bung
- Ball cage 'O' Ring
- Valve Housing Gasket
- Cover Seal

Replace the part if these features occur.

Rubber components are prone to absorbing milk fat when alkaline detergents are not used regularly. This will show as swollen or distorted parts, in which case replacement of the part is required.

The condition of the following parts can affect the Milk Meter calibration. Inspect each part for cracking, chipping, or scratching. These may be due to impact damage during handling or transport, or scratching as a result of incorrect manual cleaning procedures.

- Cover
- Base Assembly
- Flask

DO NOT use brushes inside the cover or base assembly.

DO NOT use any solid implement to clean divider orifice lips.

If the above faults exist on any of the parts of the Milk Meter, the parts will require replacement. The Milk Meter should then be repaired, tested and recalibrated according to the procedure in section 13 "Repair and Recalibration."

11. PERIODIC TEST PROCEDURE

In conjunction with the periodic Milk Meter inspection, all Milk Meters should be checked for accuracy at least annually.

This test procedure is the same as that specified by the DHIA and approved by ICAR.

11.1. BASIC TEST RIG SET UP (refer to Fig 11.1)

1. The Milk Meter is mounted such that the meter base is level.
2. The Milk Meter suction hose rests in an open 18 litre (40lb) pail (D) directly below the meter. It has an inlet restrictor (G) to ensure a flow of 3.5 to 4.0 litres per minute at the available vacuum level. An air admission hole (F) 600mm (24 inches) from the meter inlet admits 0.5 cfm (free air) (15 l/min FA). This hole size is 1mm (No.60 drill).
3. The Milk Meter outlet hose falls directly to the inlet of a vacuum trap (H), (for example test bucket, pail milker, or weigh jar). The vacuum trap outlet is connected to a stable vacuum source of nominally 50kPa (15" Hg).
4. A vacuum tap (C) is fitted on the Milk Meter inlet hose and the vacuum source hose (B).
5. Volumetric flasks or accurate scales will be required.

11.2. BASIC TEST PROCEDURE

1. Using water as the working fluid fill the supply pail (D) with 16 litres (16 kg or 35.24lb).
2. Open the source vacuum tap (B). (Inlet tap C closed).
3. Ensure the three way tap is wet, properly seated and in the horizontal (milking) position.
4. Open the inlet hose tap (C).
5. Draw all of the water from the supply pail (D) through tube (E) past the air admission hole (F) through the Milk Meter (A) and into the vacuum trap (H).
6. Record the Milk Meter flask reading. (Read the bottom of the meniscus).
7. Turn the three way tap to drain (upwards) and operate the flask depressor to empty the flask.
8. When flask is empty close the source vacuum tap (B).

9. When vacuum trap (H) has returned to atmospheric pressure close the inlet hose tap (C).
10. Return the three way tap to 'milking' position, refill the supply pail with exactly 16 litres of water and repeat the procedure, to obtain two results per meter.

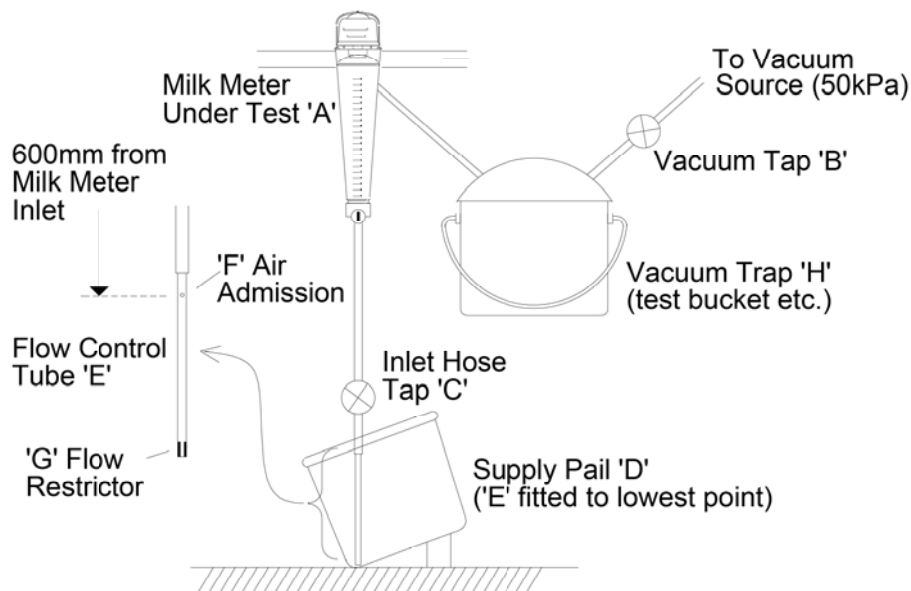

Fig 11.1 Basic Milk Meter Test Rig

11.3. RESULTS ANALYSIS

Calculate the 'p-values' for each reading as follows:

(working in kilograms)

$$p = \frac{\text{meter reading}}{16.48} \times 100\%$$

If both 'p-values' are in the range 97% to 103% the Milk Meter is considered acceptable.

If only one of the 'p-values' is outside the range 97% to 103%, perform the test a third time. The meter is then considered acceptable if no single 'p-value' is outside the range 95% to 105% and the mean of all three values is within the range 97% to 103%.

Any Milk Meter failing this test should be withdrawn from service and submitted to a certified service agent for repair and recalibration.

Note: The periodic test procedure should be regularly followed to give confidence in Milk Meter results.

12. REPAIR AND RECALIBRATION PROCEDURE

This section covers repair and recalibration of the Waikato Milk Meter, which may be undertaken only at a certified Repair and Recalibration Centre (e.g. DHIA in the USA).

Milk Meters submitted to this procedure will be those that have damaged calibration dependent parts, or those which fail the Periodic Test Procedure.

12.1. DAMAGED MILK METERS

The parts of a Milk Meter that may affect calibration are the flask, cover, and base assembly (Parts L, A and D Fig 3.3).

Damaged parts should be replaced and the other main parts closely inspected as per the 'Periodic Inspection Procedure'.

The Milk Meter is then re-tested under the 'Periodic Test Procedure'. The resultant meter p-values must meet the criteria specified.

12.2. MILK METERS THAT FAIL 'PERIODIC TEST PROCEDURE'

With only three parts to interchange, a simple process of elimination is used to recalibrate the Milk Meter.

- Replace the base assembly and retest.
- If the meter fails, replace the cover and retest.
- If the meter fails, replace the flask and retest.

A failure at this point is unlikely, but if a single case occurs, repeat the inspection and replacement procedure. If a large number of failures occur at this point, check test rig and testing procedure for any points of non-compliance with these recommended procedures.



WAIKATO Mk V Milk Meter Warranty

TECHNICAL MANUAL
SECTION 13
Issue C
Page 29

Waikato Milking Systems NZ Limited warrants the **Waikato Mk V Milk Meter** to be free from defect (fair wear and tear excepted) for a period of **ONE YEAR** from the date of installation.

Waikato Milking Systems NZ Limited will at its option repair or replace any defective **Waikato Mk V Milk Meter** or component parts. Waikato Milking Systems NZ Ltd accepts no liability for any other claim arising out of any supply of defective units.

Waikato Milking Systems NZ Limited accepts no liability where damage to the unit has resulted from the attachment to or use in connection with the unit, of other equipment, parts or components, which have not been purchased from Waikato Milking Systems NZ Limited.

Waikato Milking Systems NZ Limited accepts no liability where damage to the unit has occurred during installation, or has arisen from unauthorised adjustment of the unit.

Waikato Milking Systems NZ Limited's liability under any claim shall not exceed the price (excluding GST) of the unit.

Claims must be lodged through the Waikato Milking Systems dealer responsible for the installation.

This warranty is conditional upon the **Waikato Mk V Milk Meter** being installed and maintained in accordance with the specifications and guidelines contained in this manual.

Refer also to Waikato Milking Systems NZ Limited's Terms and Conditions of Sale for Components.